

Operation of Separators

1. INTRODUCTION	492
2. GENERAL CALCULATING METHODS	494
2.1 Definition of a Closed Grinding Circuit	494
2.2 Basic Equations (Mass Balance)	494
2.3 Circulating Load	496
2.4 Separator Efficiency	496
2.5 Classification (Tromp) Curve	498
2.6 Features of the Classification Curve	498
3. TEST PROCEDURE	502
3.1 Target of Test and Conditions	502
3.2 Sampling and Duration of Test (figures 11, 12, 13)	502
3.3 Sieve Analysis	502
3.4 Evaluation of Test Results	504
4. PRACTICAL CALCULATION AND EXAMPLE	505
4.1 Data of Separator and Mill	505
4.2 Test	506
4.3 Sampling and Sieve Analysis	506
4.4 Evaluation	507

1. INTRODUCTION

The ideal situation in grinding would stipulate that a particle of feed would be discharged from the grinding circuit as soon as it has been reduced to the required size. Thus, the grinding forces would be applied only to the oversize particles. However, due to the action of tumbling mills, any attempt to reduce all the feed to a finished product in one step results in costly overgrinding.

To control top size of discharge from the grinding circuit, sizing apparatus such as an air separator is employed, and the oversize constitutes the circulating load to the mill. In this manner, particles greater than a specified maximum size are prevented from leaving the circuit, and particles below the desired size are not recirculated through the mill.

The separation itself has an essential influence on the grinding performance in the mill, and therefore it is necessary to evaluate characteristics performance figures.

Proper functioning is mainly influenced by:

- Separator adjustment and technical condition, e.g. distributor plate speed, number and position of spin rotor blades, wear on fan and spin blades, air in-leaks, etc.
- Separator feed, e.g. feed rate, particle size distribution, moisture content, density, etc.
- Separation air, e.g. temperature, density, viscosity, moisture content, etc.

Four levels of representation of separator performance are recognized, in which:

- a) Only the total mass of the coarse (or fine) stream is considered relative to the mass of feed, expressed by the term 'yield'. This is the simplest form of assessment.
- b) Cumulative size distributions of feed, fine and coarse streams are included, leading to the term 'recovery' or 'efficiency'.
- c) The extent to which a feed size class appears in the fine and coarse stream is calculated for all size classes and leads to the term 'classification function' or 'Tromp curve' with its characteristics parameters cut point, sharpness off cut and by-pass.
- d) Stochastic errors are taken into account (not dealt with in this paper).

Figure 1 Mechanical Air Separator

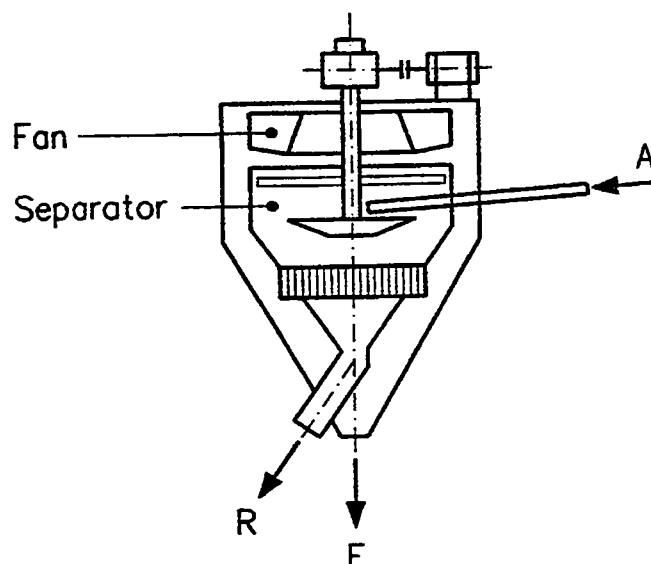

Figure 2 Cyclone Air Separator (Rotor Type)

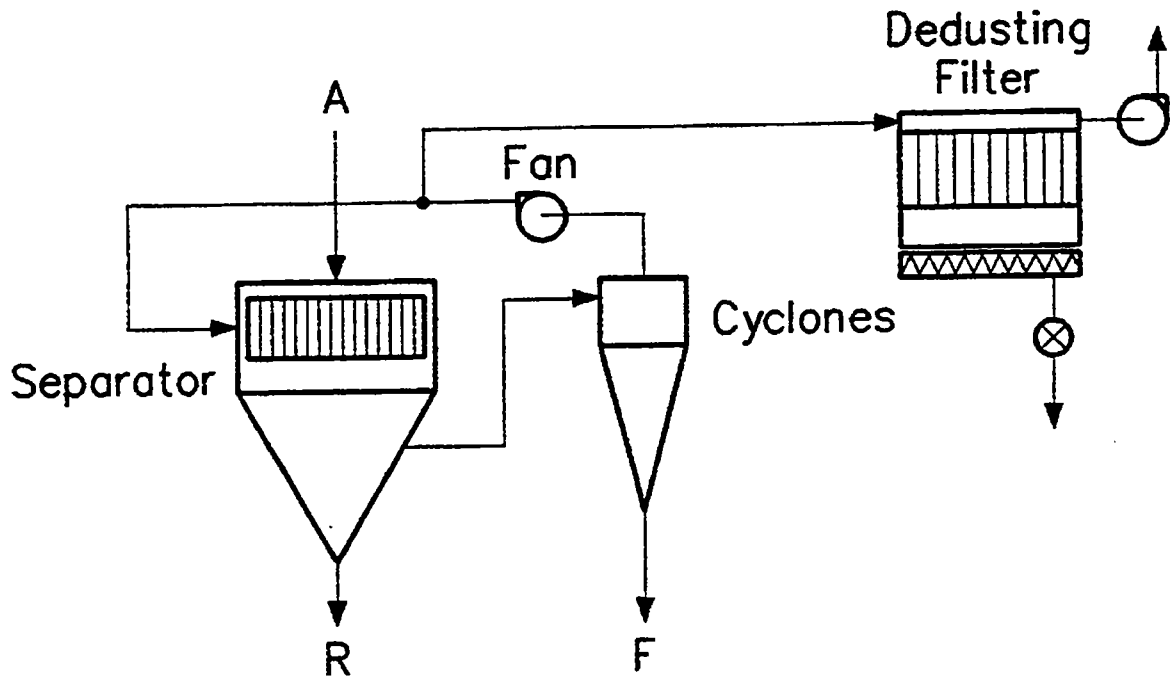
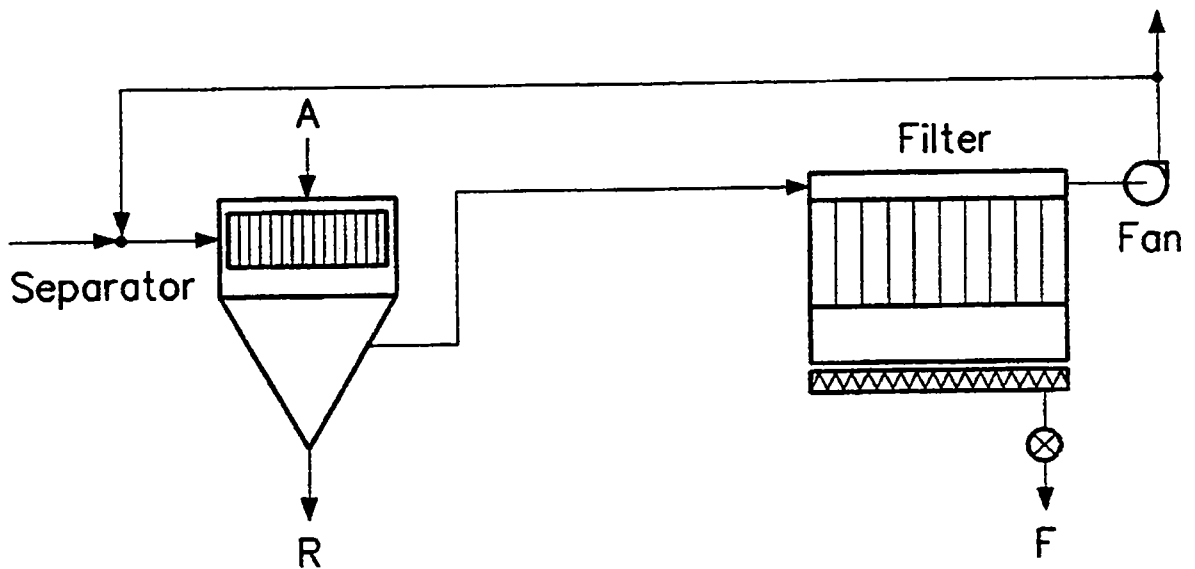

Figure 3 Single Pass Separator (Rotor Type)



2. GENERAL CALCULATING METHODS

2.1 Definition of a Closed Grinding Circuit

If the oversize in the mill discharge is recycled to the mill after a classification stage, the mill is considered to be operating in a closed circuit.

Figure 4 Symbols used for Mass Balances

Description	Mass flow [t/h]	Fineness [%] passing	Spec. surface [cm ² /g], Blaine
Mill feed	M	-	-
Separator feed (= mill discharge)	A	a	B _A
Fine fraction (Product)	F	f	B _F
Coarse fraction (Tailings)	R	r	B _R

2.2 Basic Equations (Mass Balance)

In steady-state operation, the mass flow of feed is equal to the sum of mass flows of fine and coarse streams.

$$A = F + R \quad \text{eq. (1)}$$

A mass balance can also be formulated for a portion of the streams finer than a certain particle size x [μm] (see **figure 5**).

Let a , f and r denote the percentage finer than size x in the feed, fine and coarse stream. As long as no comminution takes place in the separator, the amounts of material less than size x entering and leaving the separator are equal, hence:

$$A \cdot a = F \cdot f + R \cdot r \quad \text{eq. (2)}$$

The values of a , f and r are found by a particle size analysis (e.g. sieve analysis, laser diffraction analysis, etc.).

Yet another formulation of the mass balance can be made for a portion which is limited by a lower and upper particle size x_1 and x_2 (see **figure 5**).

Let a , f and r denote the percentage of material finer than size x_2 and larger than size x_1 in the feed, fine and coarse stream. As long as no comminution takes place in the separator, the amounts of material between x_1 and x_2 that enter and leave the separator are equal, hence:

$$A \cdot \Delta a = F \cdot \Delta f + R \cdot \Delta r \quad \text{eq. (3)}$$

The values of a , f and r are found by a particle size analysis.

Figure 4 Symbols

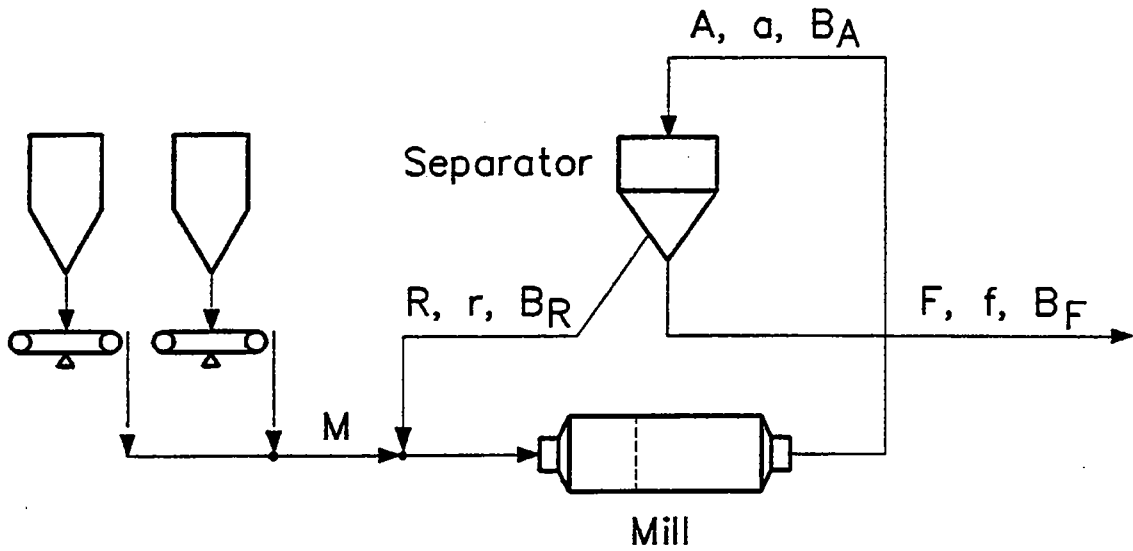

Basic equations

$$A = F + R$$

$$A \cdot a = F \cdot f + R \cdot r$$

$$A \cdot \Delta a = F \cdot \Delta f + R \cdot \Delta r$$

Figure 5 Definition Fineness

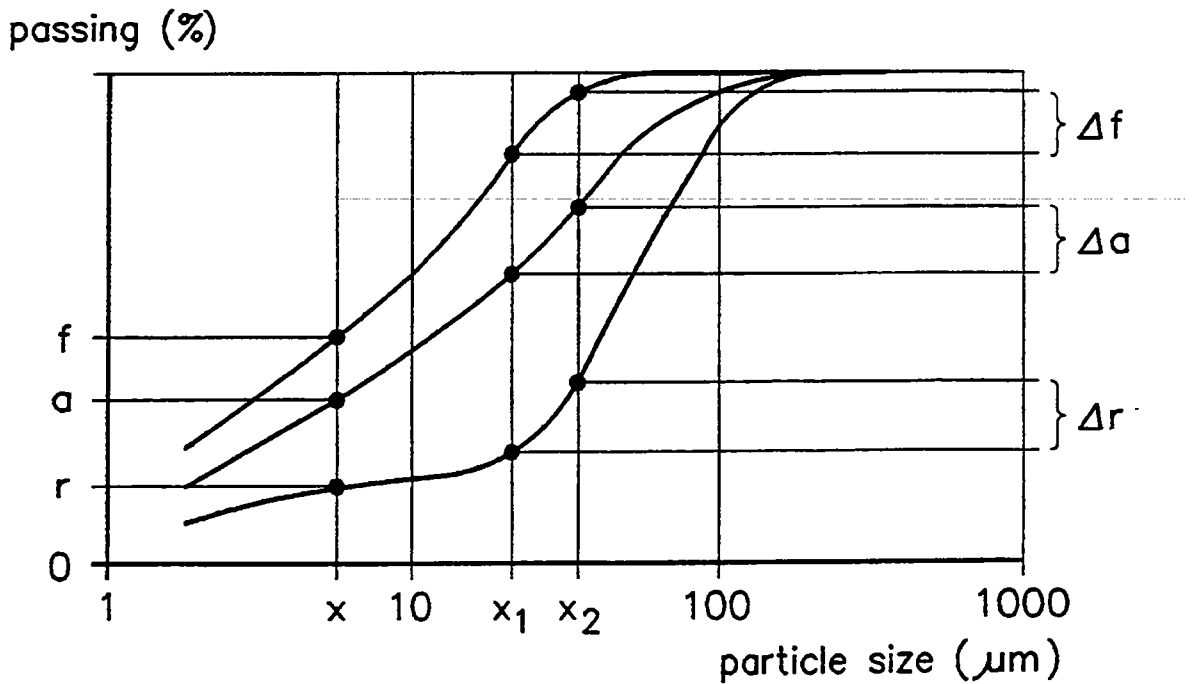

2.3 Circulating Load

The circulating load in closed-circuit grinding is defined as the mass of the separator feed A divided by the mass of the fine fraction F, or :

$$u = \frac{A}{F} \qquad \text{eq. (4)}$$

The actual value of the circulating load depends on various factors, such as mill design, grinding efficiency, product fineness, etc., but as a guide the following values can be given:

Cement mill	low fineness	u = 1.5 to 2
	high fineness	u > 2
Raw mill		u = 2 to 2.5

2.3.1 Calculation of Circulating Load

Formula (4) can be used directly if the mass flows of fines and feed (or rejects) are given. Most mills are equipped with weigh feeders, so M is known, which is equal to F in steady-state operation.

If no weighing equipment for separator feed or rejects is installed, u must be determined using particle size analysis data and formula (1), (2).

$A = F + R \quad (1)$	$A.a = F.f + R.r \quad (2)$	$u = A/F \quad (4)$
-----------------------	-----------------------------	---------------------

$$u = \frac{(f - r)}{(a - r)} \qquad \text{eq. (5)}$$

It is recommended to use the u-values calculated by this formula with caution, because inevitable errors in the determination of the particle size distributions affect the result considerably.

2.4 Separator Efficiency

Efficiency takes some account of size distribution, to the extent that it is defined as the recovery of a feed size class (0 to x μm) into the fines stream.

$$\eta(x) = \frac{F.f}{A.a} \cdot 100[\%] \qquad \text{eq. (6)}$$

$$\eta(x) = \frac{f}{u.a} \cdot 100[\%] \qquad \text{eq. (7)}$$

If x is chosen as the maximum particle size present in the feed, η(x) is equal to 1/u.

Figure 6 shows efficiency curves for two different values of u.

Figure 6 **Circulating Load, Efficiency**

Circulating load

$$u = \frac{A}{F}$$

$$u = \frac{f-r}{a-r}$$

Separator efficiency

$$\eta = \frac{f}{u-a}$$

efficiency (%)

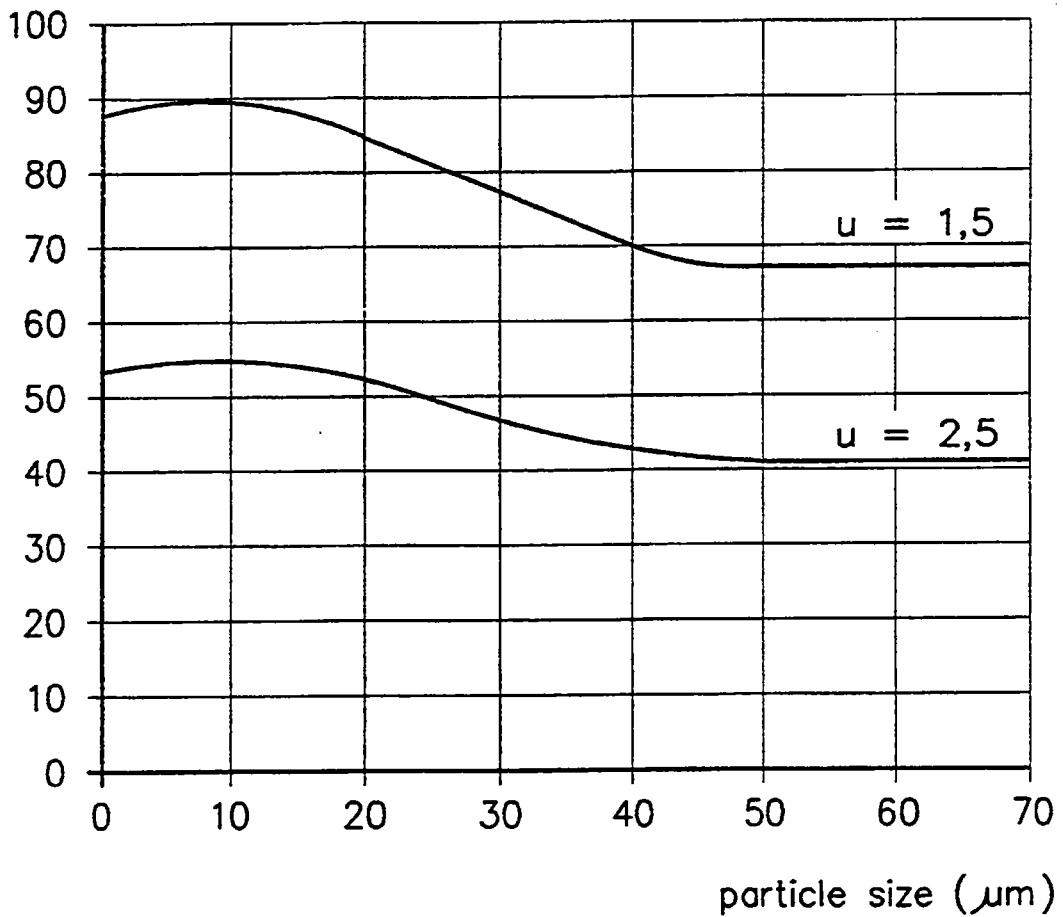

2.5 Classification (Tromp) Curve

The information given by the efficiency curve is not detailed enough because the defined fractions 0 to x [μm] are wide.

If we ask for the recovery of a feed size class with lower limit x_1 and upper limit x_2 (x_1 greater zero) into the coarse stream, we arrive at the Tromp value for the coarse stream.

$$t_r = \frac{R \cdot \Delta r}{A \cdot \Delta a} 100[\%] \quad \text{eq. (8)}$$

or

$$t_r = \frac{\Delta r}{\Delta a} \left(1 - \frac{1}{u}\right) 100[\%] \quad \text{eq. (9)}$$

If this ratio is obtained for a number of size classes and plotted against x, there results the classification curve (**figure 7**). It is also called the Tromp curve after the name of the man to whom it is assigned.

2.6 Features of the Classification Curve

2.6.1 Cut Point

The cut point d_{50} corresponds to 50 % of the feed passing to the coarse stream as seen in **figure 8**. It is therefore that size which has equal probability of passing to either coarse or fine streams.

2.6.2 Sharpness of Separation

The sharpness of separation is defined as follows:

$$k = \frac{d_{75}}{d_{25}} \quad \text{eq. (10)}$$

where d_{75} and d_{25} denote the sizes with Tromp values of 75 % and 25 % (**figure 8**).

For an ideal separation k would be 1.

2.6.3 By-Pass Effect

Ideally, the Tromp curve is asymptotic to the abscissa at ordinate values of zero and unity.

In practice, it is often the case that the lower asymptote occurs at ordinate values a ' greater than zero (**figure 9**), i.e. a portion of each size fraction bypasses the classifying action. Expressed in an other way, part of the feed reports to the coarse stream independently of its particle size.

Experience has shown that the bypass parameter a' varies with classifier feed rate, and hence it is difficult to describe a single Tromp curve which is representative of the classifier.

Figures 7, 8 & 9 Tromp Curves

Basic equations

$$t_r = \frac{\Delta r}{\Delta a} \left(1 - \frac{1}{u}\right) 100$$

Figure 7 Tromp Curves (continued)

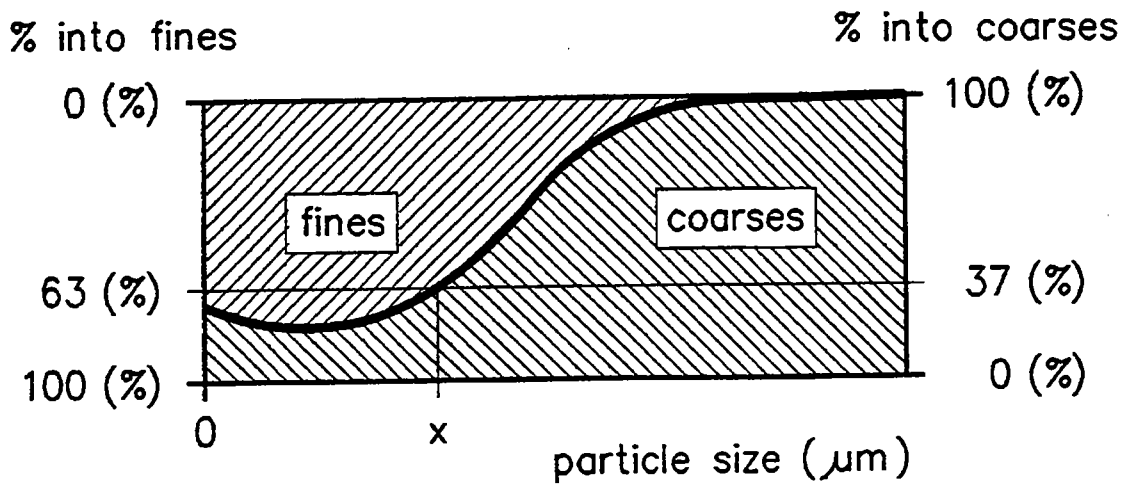

Figure 8 Tromp Curves (continued)

sharpness of cut $k = \frac{d_{75}}{d_{25}}$

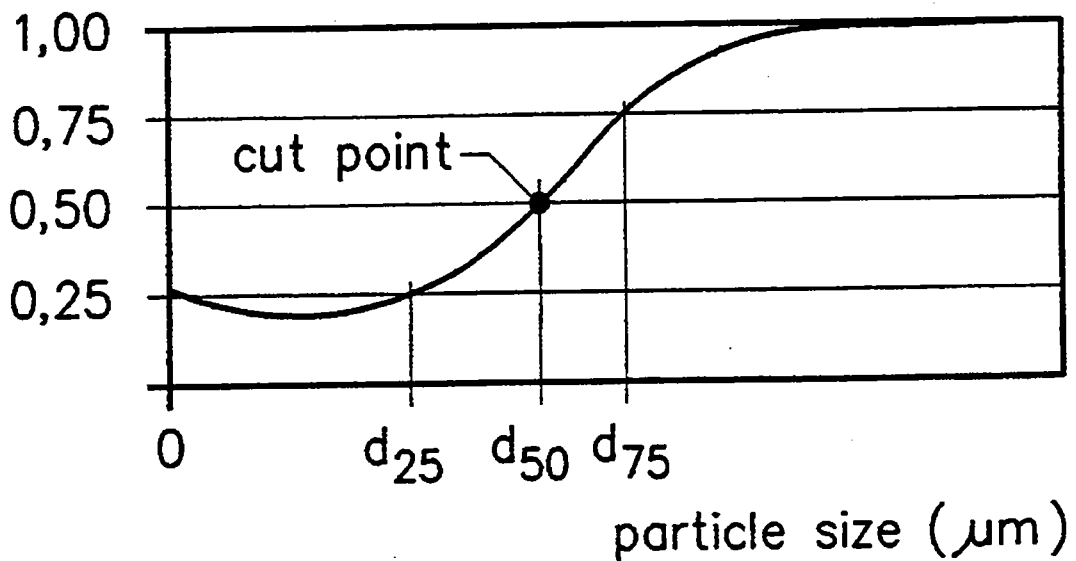
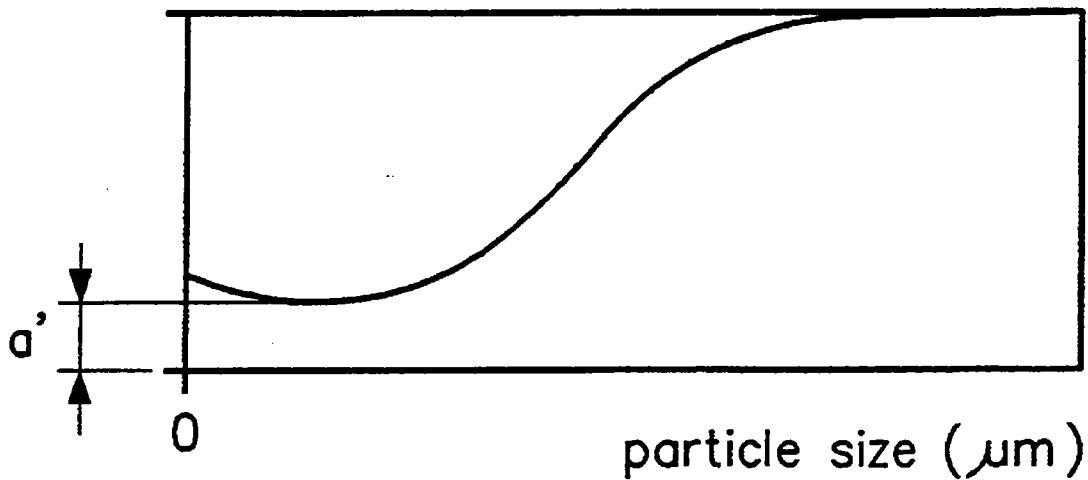

Figure 9 Tromp Curves (continued)

bypass a'



With mechanical air separators of Heyd or Sturtevant type it frequently happens that the bypass value exceeds 50 %, so that the definitions given above for d_{50} and k are no more applicable.

It is then common practice to introduce a separator model which explicitly includes the bypass effect, shown in **figure 10**.

The 'reduced' Tromp curve with

$$t_r^* = \frac{(tr - a')}{(100 - a')} \cdot 100 [\%]$$

allows for determination of d_{50} and k^* .

Figure 10 Separator Model

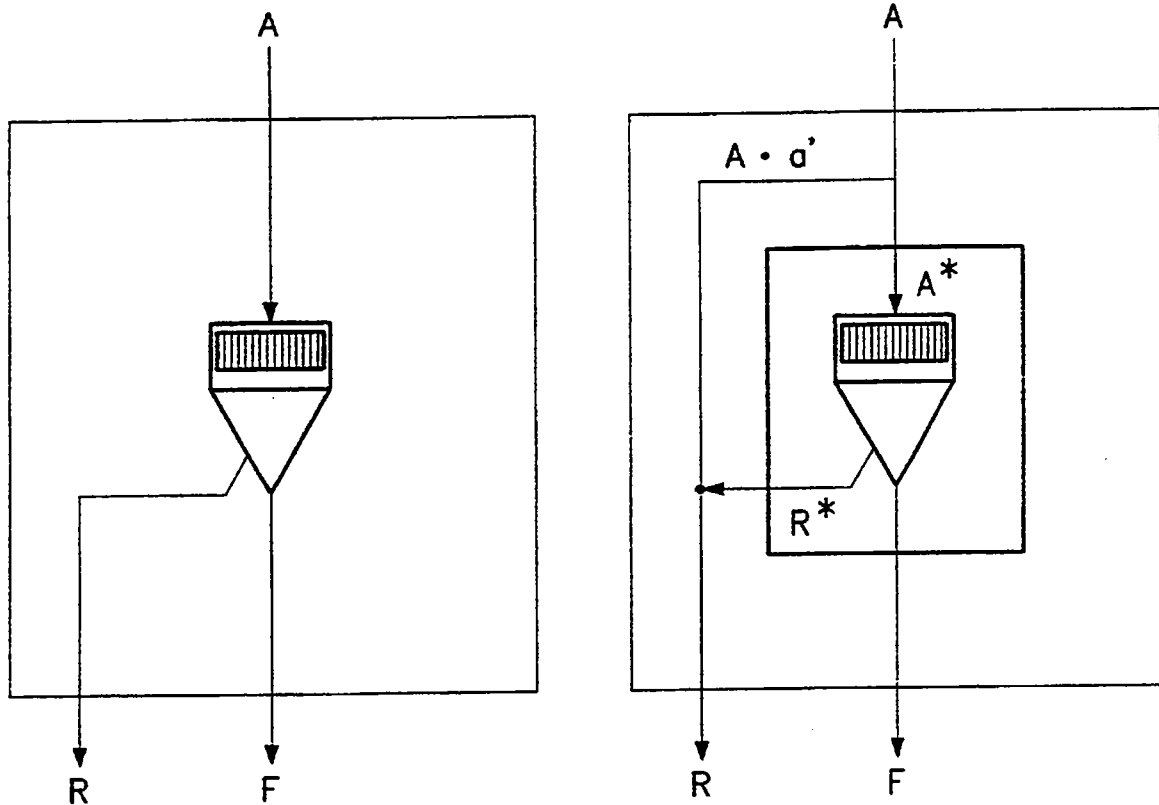

$$t_r = \frac{R \Delta r}{A \Delta A}$$

$$t_r^* = \frac{R^* \Delta r^*}{A^* \Delta a^*}$$

$$R^* \Delta r^* = R \Delta r - a' A \Delta a$$

$$A^* = A(100 - a')$$

$$t_r^* = \frac{R \Delta r - a' A \Delta a}{A A (100 - a') \Delta a}$$

$$t_r^* = \frac{(t_r - a')}{(100 - a')}$$

3. TEST PROCEDURE

3.1 Target of Test and Conditions

The separation result is characterized by weight and fineness of coarse and fine streams. These values and the operating variables which affect separator performance (e.g. separator adjustment, feed, separating air, etc.) must be recorded during the test.

Since separator performance is strongly dependent on feed rate and feed size distribution, it is of utmost importance that stable operation of the mill is maintained during the test, which in this context means constant classifier feed rate.

Variables correlated with this figure are e.g. power consumption of the bucket elevator or separator rejects mass flow (provided a scale is installed). If no automatic control system is available, the fresh feed rate to the mill must be regulated such that the power consumption of the bucket elevator is constant.

3.2 Sampling and Duration of Test (figures 11, 12, 13)

The most accurate determination of A, F and R can be done if two of the values can be measured by scales and the third value is calculated by means of equation (1). In this case, the duration of the test is about 10 minutes, and samples should be taken in intervals of 1 to 2 minutes.

It is very often that only the fresh feed M to the mill can be measured. It is assumed that the weight of the fine fraction F is equal to the mill feed M. Separator feed rate A and coarse stream R can only be determined by means of the circulating load u, which in turn is calculated applying formula (5) to the particle size distributions of A, F and R. Duration of test is about 10 minutes, and samples should be taken every 1 to 2 minutes.

Then the individual samples of each sampling point can be homogenized to one composite sample for A, F and R. Before doing this, it is recommended to check for outliers due to e.g. instable mill operation by checking the residue on a sieve of medium size, e.g. 30 μm . Samples with extreme values should be eliminated.

Two separators operating in parallel usually do not have equal feed rates, therefore it is recommended to carry out a separate test for each unit.

3.3 Sieve Analysis

As mentioned earlier, it is necessary to determine the particle size distribution (PSD) of the three samples A, F and R.

In many plants it is only possible to carry out dry sieving tests down to 30 μm . For an accurate separator judgment the PSD must be known also in the finer range. Below 30 μm , wet sieving is applied.

A more advanced method of PSD determination would be the application of a laser diffraction analyzer.

Figure 11 Sampling Points - Single Pass Separator

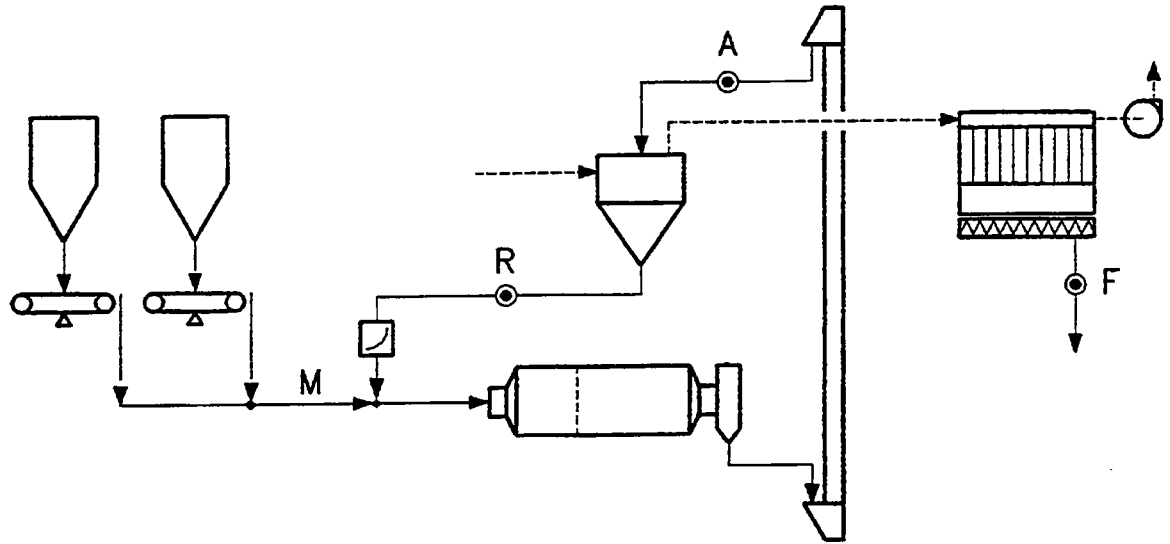

Figure 12 Sampling Points - Cyclone Air Separator

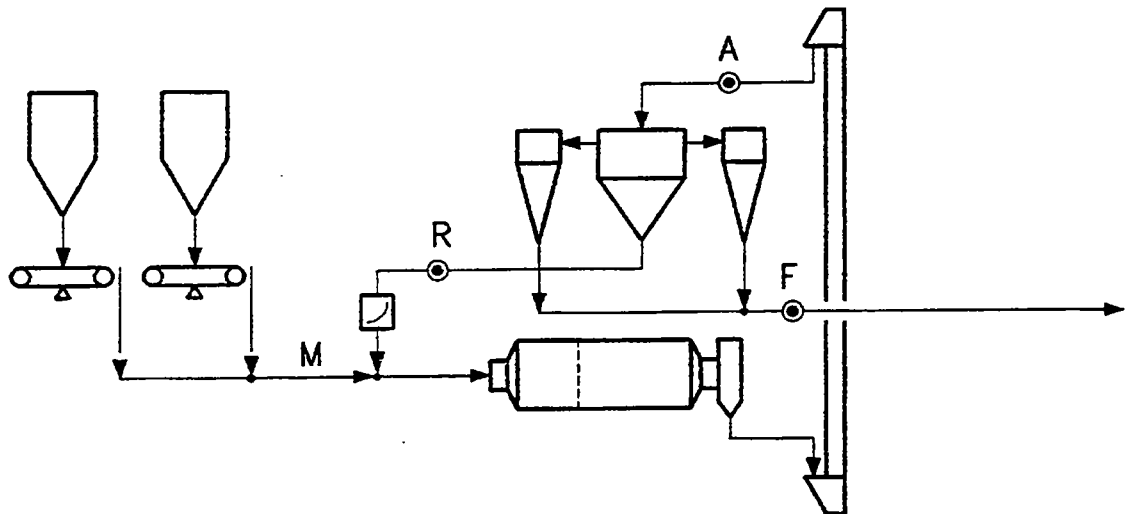
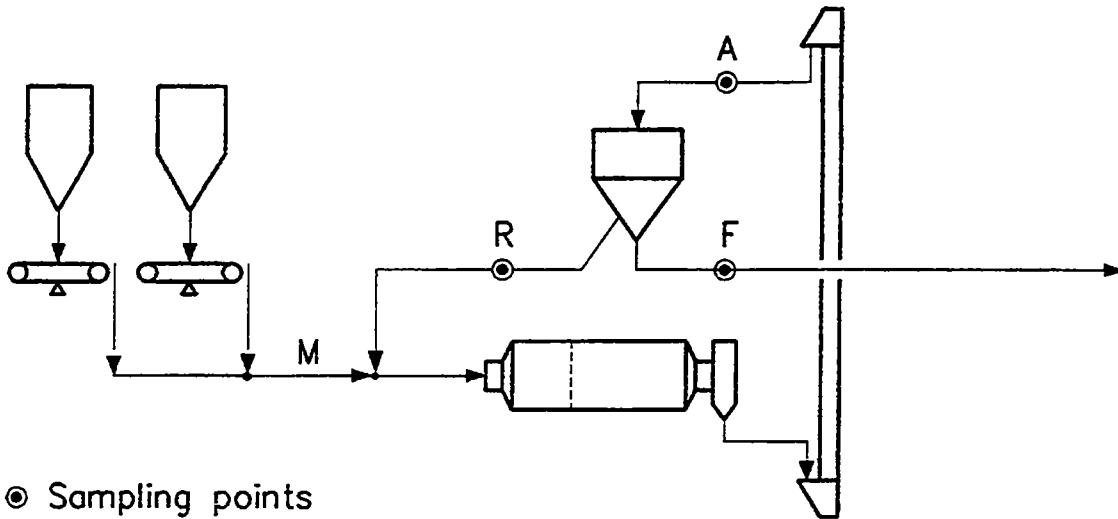

Figure 13 Sampling Points - Mechanical Air Separator



⊙ Sampling points

3.4 Evaluation of Test Results

The further procedure comprises calculation of:

- Mass balance
- Circulating load
- Efficiency, including graph
- Tromp values, including graph
- Cut point, bypass and sharpness of separation

The report at hand explains the basic methods how to carry out a separator performance test. These methods enable to define and evaluate the main operational characteristics of a closed grinding circuit, to compare them with other cases and with ideal values.

The optimum solution for a particular case must be found in several steps, the evaluation of each single step indicating a better choice of operating variables for the next one. No universal method is available to find the ideal solution at the writing desk without experiments.

4. PRACTICAL CALCULATION AND EXAMPLE

4.1 Data of Separator and Mill

Plant	A
Date of test	12.06.1991
Separator:	
Make, type	Q&K QS 225 (HES)
Rotor diameter	2.25 [m]
Rotor height	2.25 [m]
Rotor speed	120 [rpm]
Installed motor power	220 [kW]
Separation air amount	170'000 [m ³ /h]
Fineness regulation	rotor speed variation
Year of start-up	1991
Mill:	
Type	Cement mill, No. 4 Two compartment, end discharge
Diameter, length	4.2 / 15.4 [m]
Installed motor power	3'600 [kW]
Year of start-up	1980
Mill feed	Weigh feeder
Control	automatic mill control system
Flowsheet	figure 14

Figure 14 Flowsheet - Operation of Separators

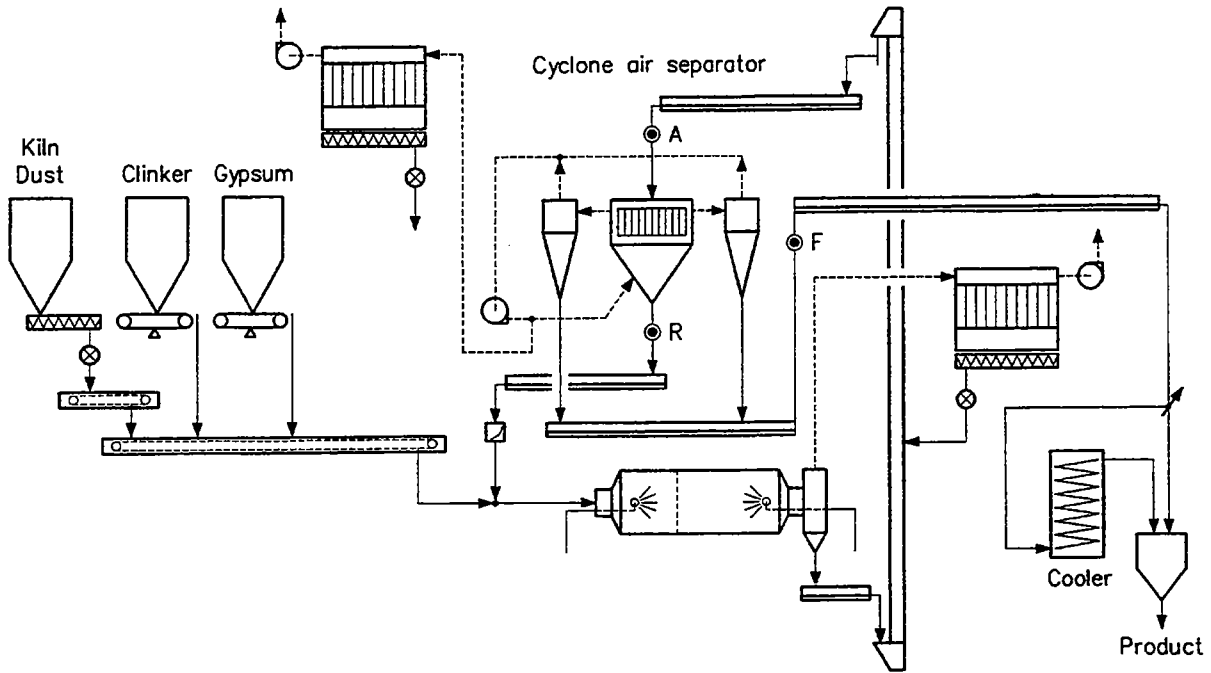

4.2 Test

During the test a cement has been produced with 93.1 % clinker, 4.6 % gypsum and 2.3 % kiln dust. Since the system was equipped with a scale for the returns, test duration was only 30 minutes.

Average mill feed rate was 120 t/h, average returns rate 126 t/h.

4.3 Sampling and Sieve Analysis

Sampling points:	shown in figure 14, marked
Number of samples:	16 per sampling point
Sieve analysis:	Particles > 200 μm dry screening Particles < 200 μm CILAS laser analyzer

The particle size distributions of feed, coarses and fines are listed in **figure 15**, the corresponding graphs are shown in **figure 16**.

4.4 Evaluation

4.4.1 Circulating Load u

1) Calculation by means of measured mill feed rate and rejects rate

$$u = \frac{A}{F} \frac{(R+F)}{F} = \frac{(126+120)}{120} = 2.05$$

2) Calculation by means of particle size distributions

$$u = \frac{(f-r)}{(a-r)} \text{ (equation 5)}$$

The circulating load for each particle size (e.g. 1,2, 4 μm etc.) can now be calculated and then the mean value of the circulating load can be determined.

A simpler form is to calculate the sum of a, f, and r and then to calculate u by means of the formula:

$$u = \frac{(\sum f - \sum r)}{(\sum a - \sum r)}$$

$$u = \frac{(607.7 - 285.1)}{(463.1 - 285.1)}$$

$$u = 1.81$$

Figure 15 Size Distribution

size (μm)	feed	coarses (% passing)	fines
1	3.6	1.9	4.9
2	6.1	3.5	8.3
4	11.0	6.3	14.7
8	18.5	10.1	25.4
16	31.2	14.4	44.9
24	39.7	16.1	58.8
32	47.8	19.1	71.1
48	60.6	28.1	87.0
64	67.7	37.1	92.6
96	81.8	59.5	100.0
200	95.1	89.0	100.0
Sum	463.1	285.1	607.7

Figure 16 Particle Size Distribution

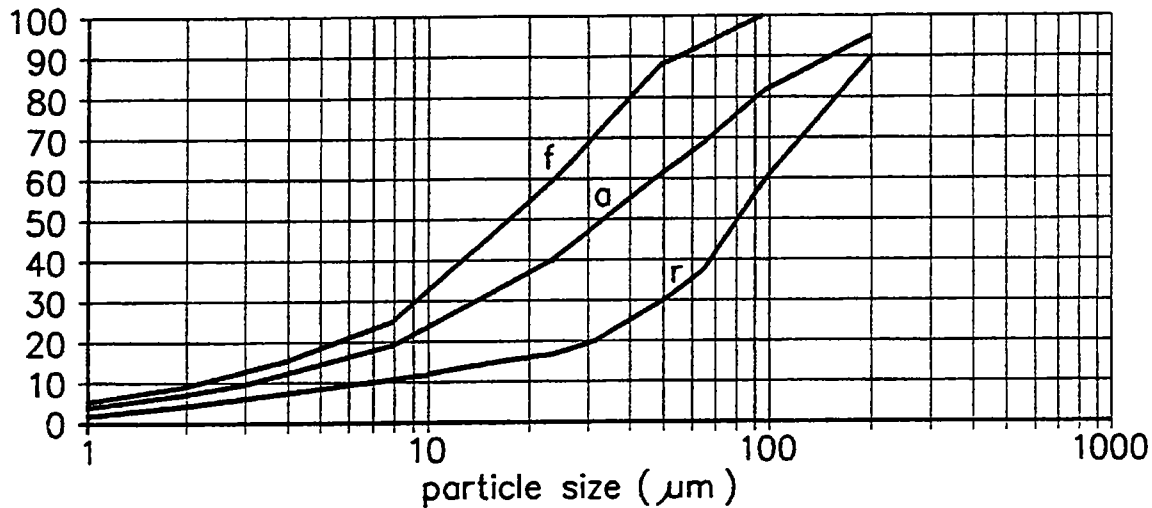

4.4.2 Separator Feed A

The mill feed M is known and is equal to F. The separator feed A can now be calculated by means of equation 4:

$$u = \frac{A}{F} \rightarrow A = u \cdot F = u \cdot M$$

$$A = 1.81 \cdot 120 = 217 [t/h]$$

4.4.3 Coarse Fraction R

$$R = A - F = 97 t/h$$

4.4.4 Efficiency

Equation 7 is used for calculating the efficiency.

$$\eta = \frac{f}{a \cdot u} \cdot 100 [\%]$$

The calculated values are listed in **figure 17**, and the corresponding graph is shown in **figure 18**. It is to state that for the calculation the value $u = 1.81$ has been used.

4.4.5 Tromp Values

Equation 9 is used for calculating the Tromp values.

$$t_r = \frac{\Delta r}{\Delta a} \left(1 - \frac{1}{u} \right) 100 [\%]$$

The calculated values are listed in **figure 17**, and the corresponding graph is shown in **figure 18**.

4.4.6 Cut Point

The cut point was determined graphically, and its value is

$$d_{50} = 52 [\mu m]$$

4.4.7 Sharpness of Separation

Equation 10 was used for the calculation

$$k = \frac{d_{75}}{d_{25}} = 3.4$$

4.4.8 Bypass

The minimum of the Tromp curve is located at 20 μm, the bypass value is 9 %.

Figure 17 Efficiency, Tromp Curve - Calculation

size (μm)	efficiency (%)	Tromp (%)
1	76.4	23.7
2	74.7	27.9
4	74.2	26.6
8	75.8	22.2
16	79.4	15.4
24	81.9	9.0
32	82.2	16.7
48	79.3	31.5
64	75.6	56.6
96	67.5	71.1
200	58.1	100.0

Figure 18 Efficiency, Tromp Curve

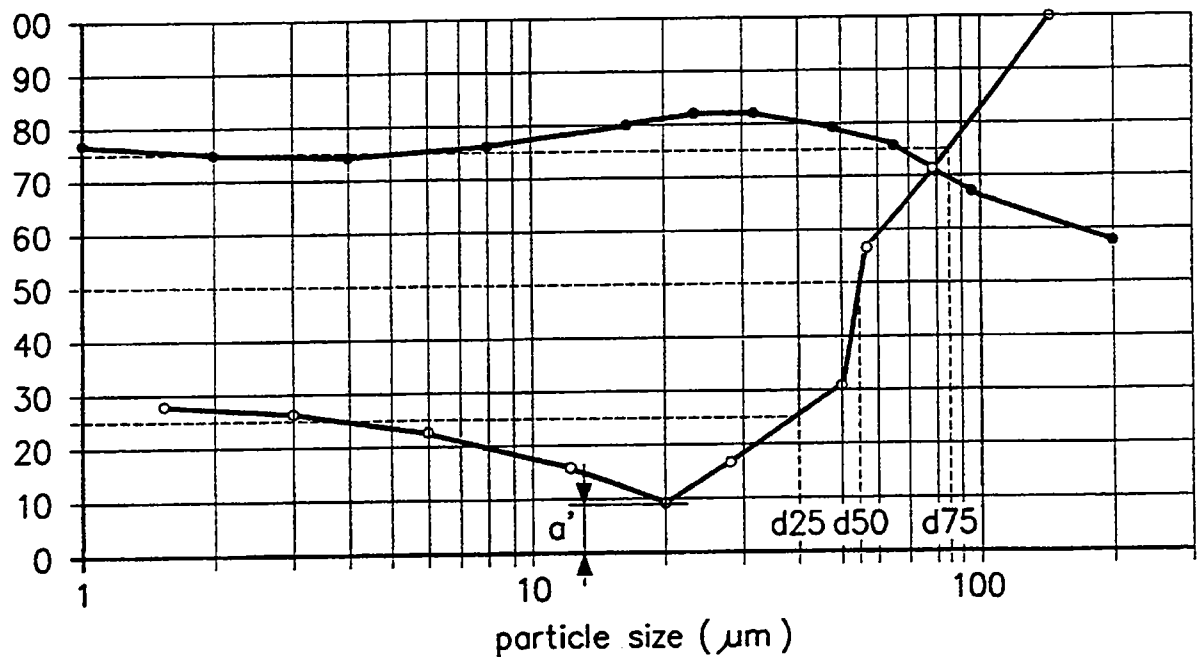

4.4.9 Specific Air Loads

$$\frac{\text{feed}}{\text{airamount}} = \frac{217'000[\text{kg/h}]}{170'000[\text{m}^3/\text{h}]} = 1.28[\text{kg/m}^3]$$

$$\text{guidevalue} \leq 2.5[\text{kg/m}^3]$$

$$\frac{\text{fines}}{\text{airamount}} = \frac{120'000[\text{kg/h}]}{170'000[\text{m}^3/\text{h}]} = 0.71[\text{kg/m}^3]$$

$$\text{guidevalue} \leq 0.8[\text{kg/m}^3]$$

4.4.10 Specific Rotor Load

D [m] rotor diameter

H [m] rotor height

$$\frac{\text{fines}[t/h]}{D^3 \cdot 14 \cdot H} = \frac{120}{2.53 \cdot 14 \cdot 2.5} = 6.1[t/m^2/h]$$

$$\text{guidevalue} \leq 10[t/hm^2]$$

4.4.11 Conclusion

The evaluation of the separator performance test shows that separator efficiency is good, bypass is low and sharpness of separation is sufficient.